

DRAWING INDEX

DRAWING NUMBER	DRAWING NAME	DRAWING REVISION
AV-D-00	INDEX SUMMARY PAGE	B
AV-D-01	NOT CURRENTLY IN USE	B
AV-D-02	ACADEMIC'S DESK LAYOUT (FLAT-FLOOR TEACHING)	A
AV-D-03	VIEWING GUIDELINES	A
AV-D-04	INDICATIVE EQUIPMENT LAYOUT AT DISPLAY DEVICE	A
AV-D-05	PROJECTOR CAGE EQUIPMENT LAYOUT (FLAT FLOOR TEACHING)	A

ANY DEVIATION FROM THE ABOVE AV STANDARD MUST BE APPROVED BY RMIT AV

B	ITS AVS 3.00 ISSUE	04 MAY 18	NK
A	ITS AVS 2.21 ISSUE	08 OCT 15	NK
REV	PURPOSE OF ISSUE	DATE	ISSUED BY

			DRAWING DESCRIPTION: AV DETAIL DRAWING INDEX SUMMARY PAGE			
PROJECT NAME						
RMIT AV STANDARDS						
DESIGNED	DRAWN	CHECKED	PROJECT REF NO	DOCUMENT REF NO	REV	
NK	NK	XX	AV STANDARD	AV-D-00	B	
PAPER SIZE	SCALE	SHEET				
A1	NTS	1 OF 6				

NOT CURRENTLY IN USE

NOTES:

ANY DEVIATION FROM THE ABOVE AV STANDARD MUST BE APPROVED BY RMIT AV

B	ITS AVS 3.00 ISSUE	04 MAY 18	NK
A	ITS AVS 2.21 ISSUE	08 OCT 15	NK
REV	PURPOSE OF ISSUE	DATE	ISSUED BY

			DRAWING DESCRIPTION: AV DETAIL DRAWING INDICATIVE RACK LAYOUTS			
PROJECT NAME			RMIT AV STANDARDS			
DESIGNED	DRAWN	CHECKED	PROJECT REF NO	DOCUMENT REF NO	REV	
NK	NK	-	AV STANDARD	AV-D-01	B	

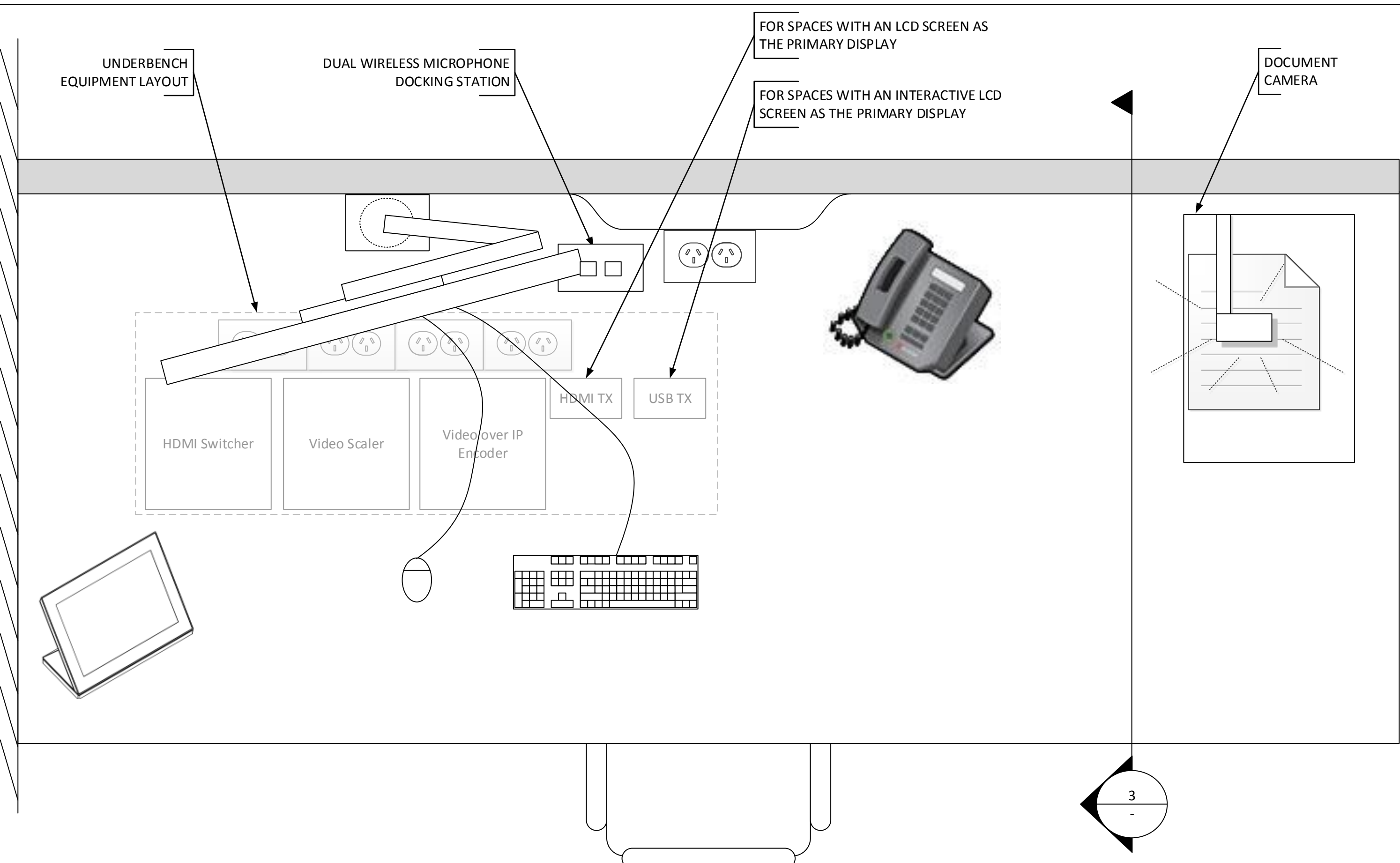

1 PLAN – ACADEMIC'S DESK (LEFT)
NTS

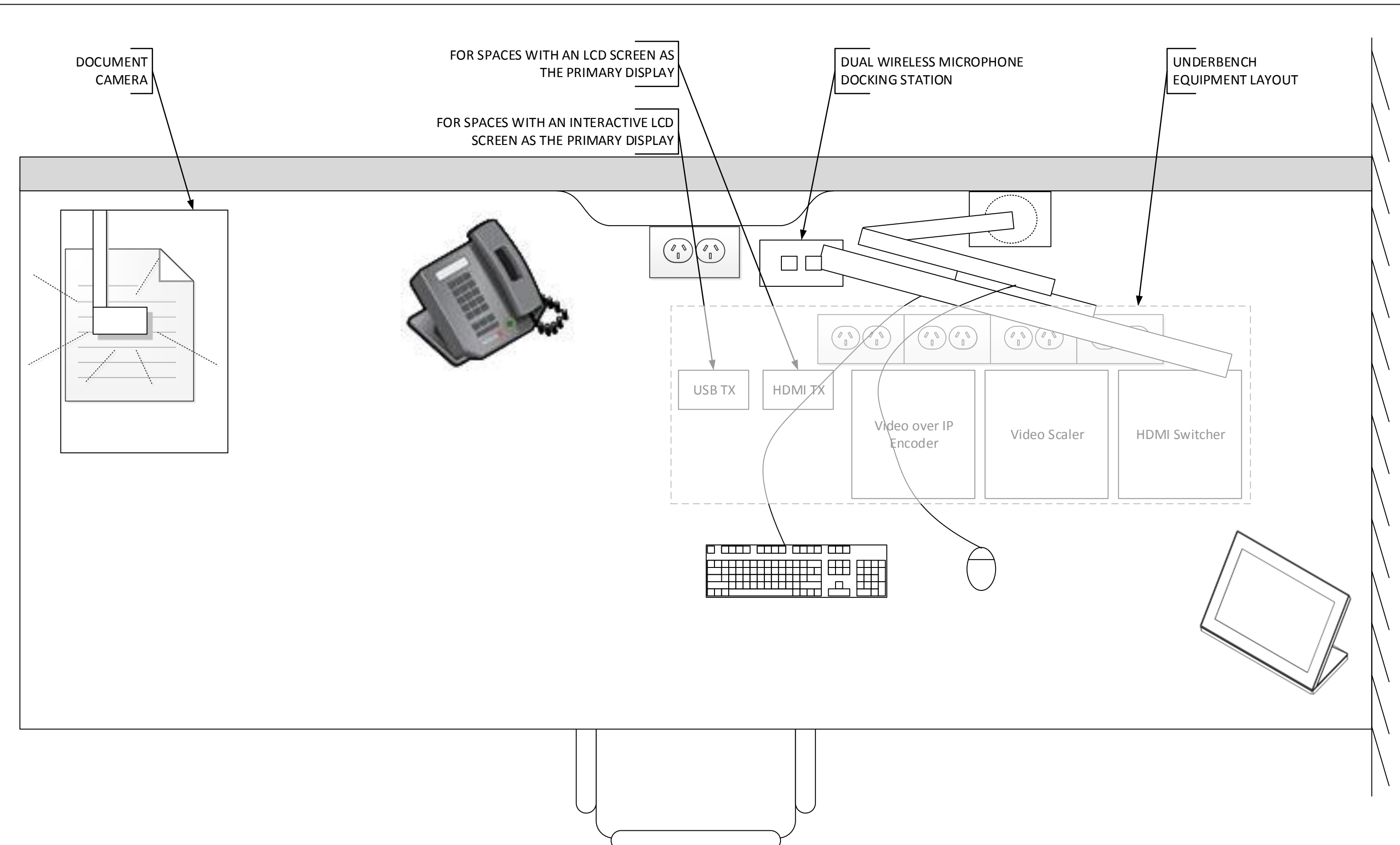

2 PLAN – ACADEMIC'S DESK (RIGHT)
NTS

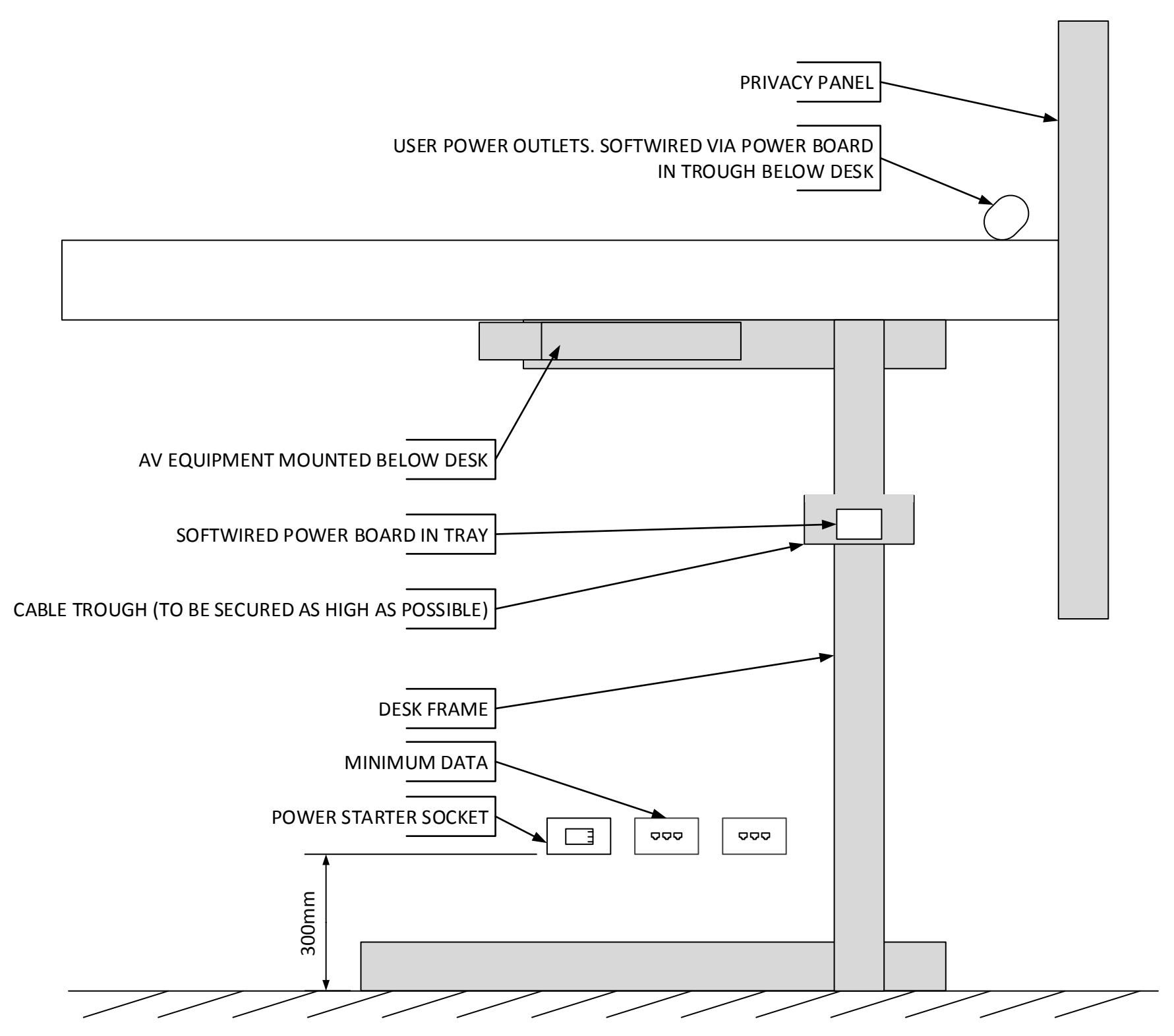

3 SECTION – ACADEMIC'S DESK
NTS

NOTES:
-

ANY DEVIATION FROM THE ABOVE AV STANDARD MUST BE APPROVED BY RMIT AV

A	ITS AVS 3.00 ISSUE	04 MAY 18	NK	PAPER SIZE	SCALE	SHEET	RMIT AV STANDARDS					
REV	PURPOSE OF ISSUE	DATE	ISSUED BY	A1	NTS	3 OF 6	DESIGNED	DRAWN	CHECKED	PROJECT REF NO	DOCUMENT REF NO	REV
							NK	NK	AA	AV STANDARD	AV-D-02	A

RMIT UNIVERSITY

DRAWING DESCRIPTION:
AV DETAIL DRAWING
ACADEMIC'S DESK LAYOUT (FLAT-FLOOR TEACHING)

PROJECT NAME:
RMIT AV STANDARDS

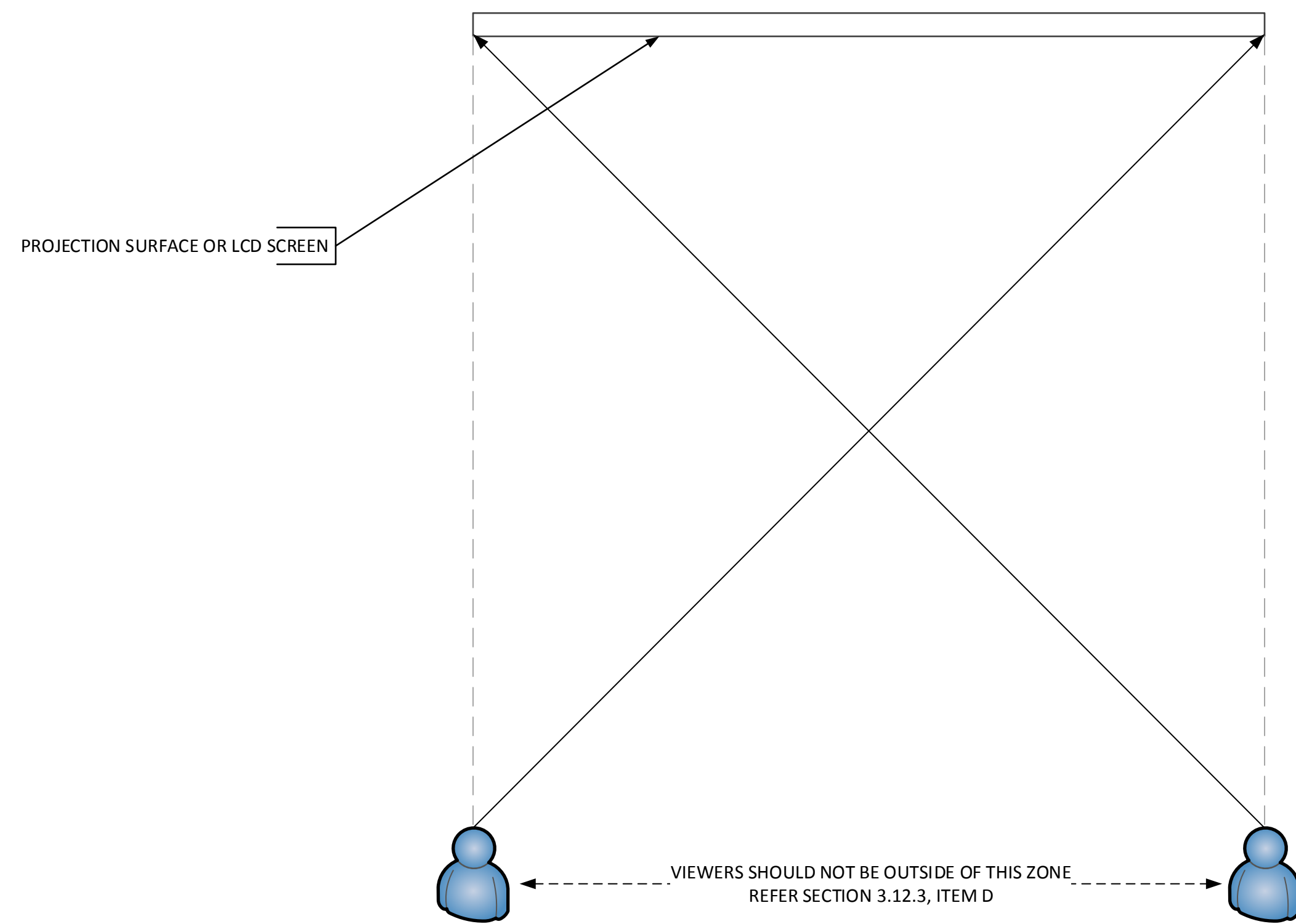

1
-
VIEWING SITELINES - HORIZONTAL
NTS

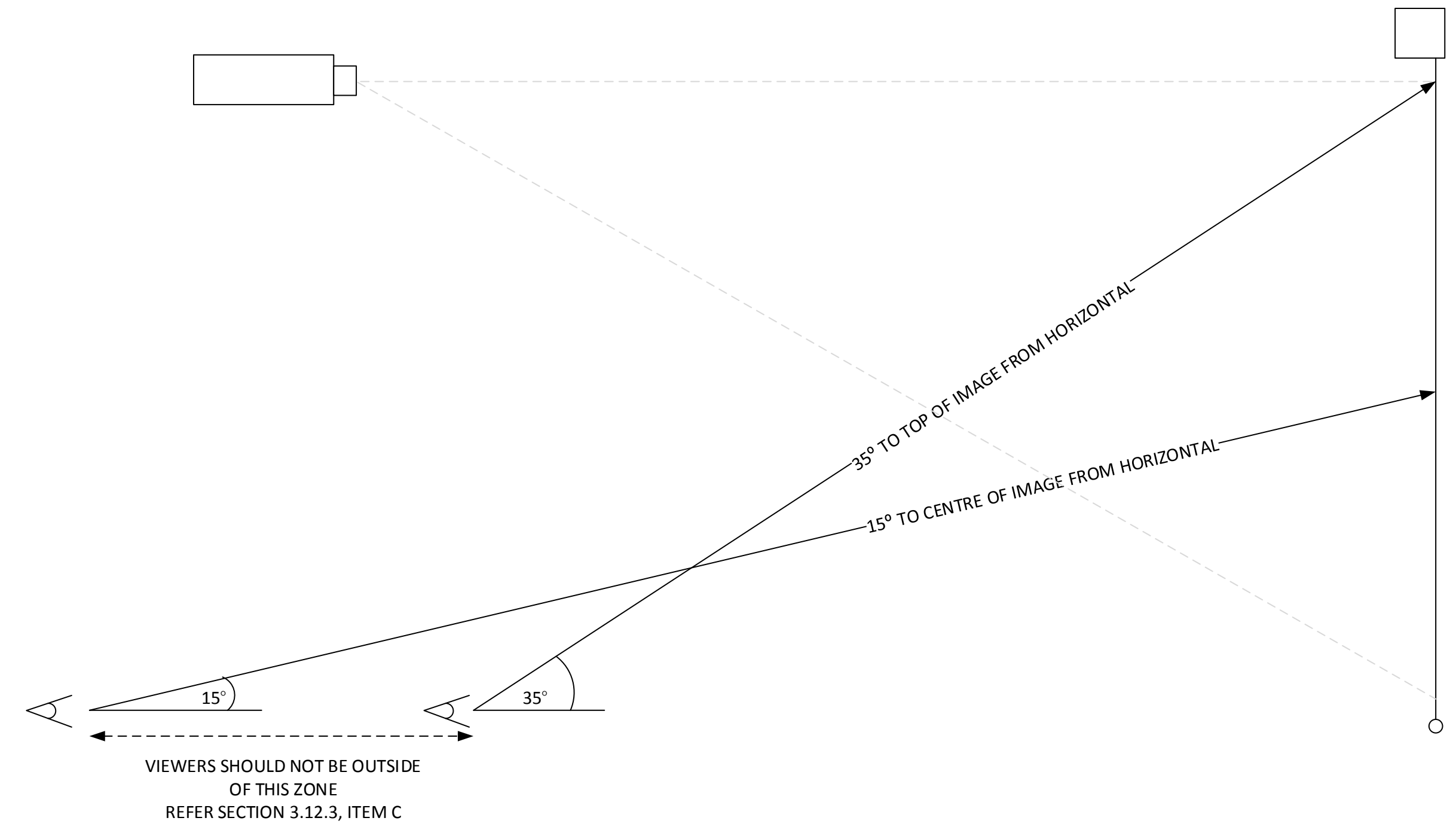

2
-
VIEWING SITELINES - VERTICAL
NTS

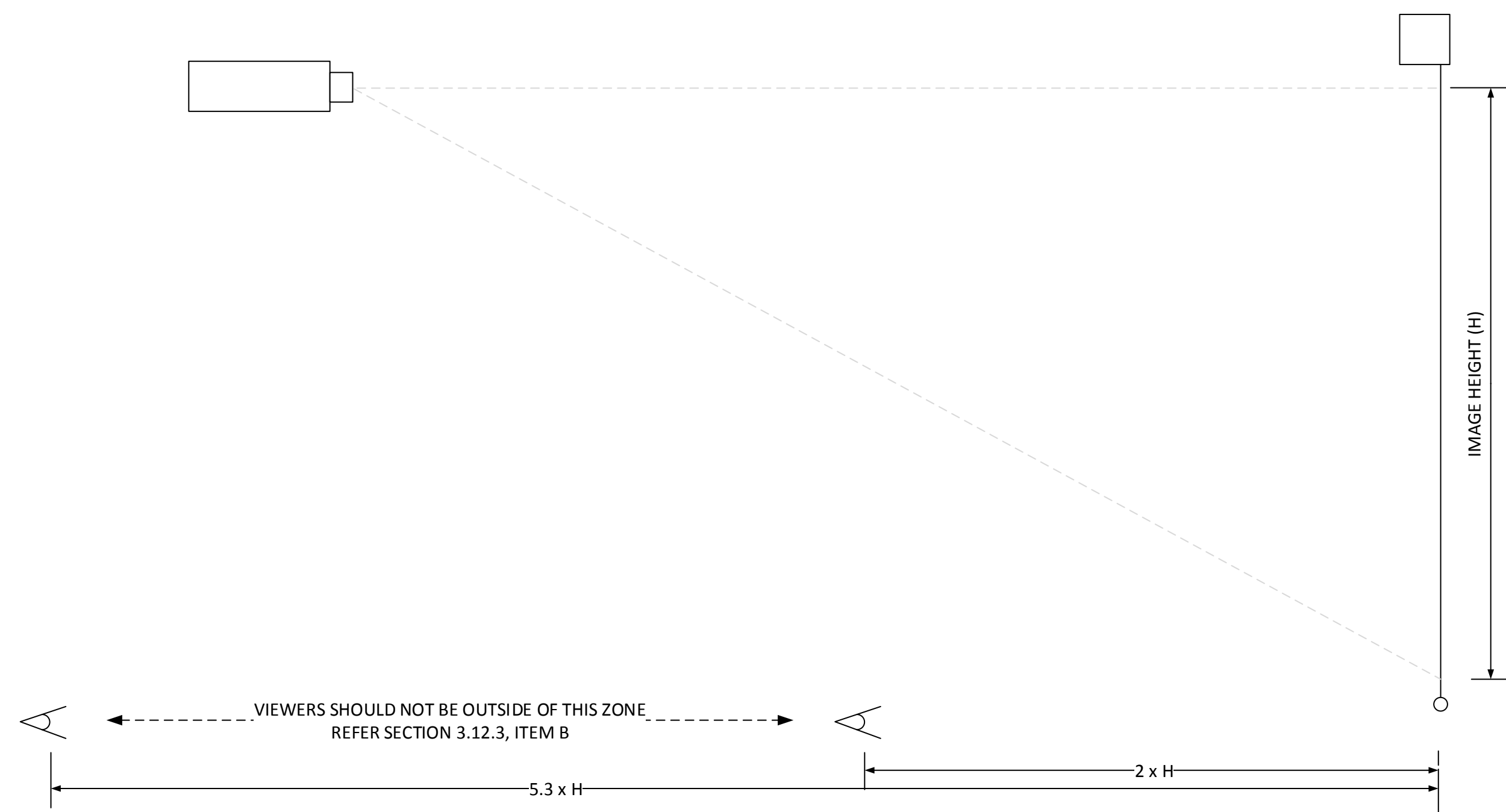

3
-
VIEWING DISTANCES AGAINST IMAGE SIZE (720P)
NTS

NOTES:

ANY DEVIATION FROM THE ABOVE AV STANDARD MUST BE APPROVED BY RMIT AV



DRAWING DESCRIPTION:		AV DETAIL DRAWING VIEWING GUIDELINES	
PROJECT NAME:		RMIT AV STANDARDS	
DESIGNED:	DRAWN:	CHECKED:	PROJECT REF NO:
NK	NK	AA	AV STANDARD
DATE:	ISSUED BY:	DOCUMENT REF NO:	REV:
04 MAY 18	NK	AV-D-03	A

PAPER SIZE:	SCALE:	SHEET:
A1	NTS	4 OF 6

A	ITS AVS 3.00 ISSUE	04 MAY 18	NK
REV	PURPOSE OF ISSUE	DATE	ISSUED BY

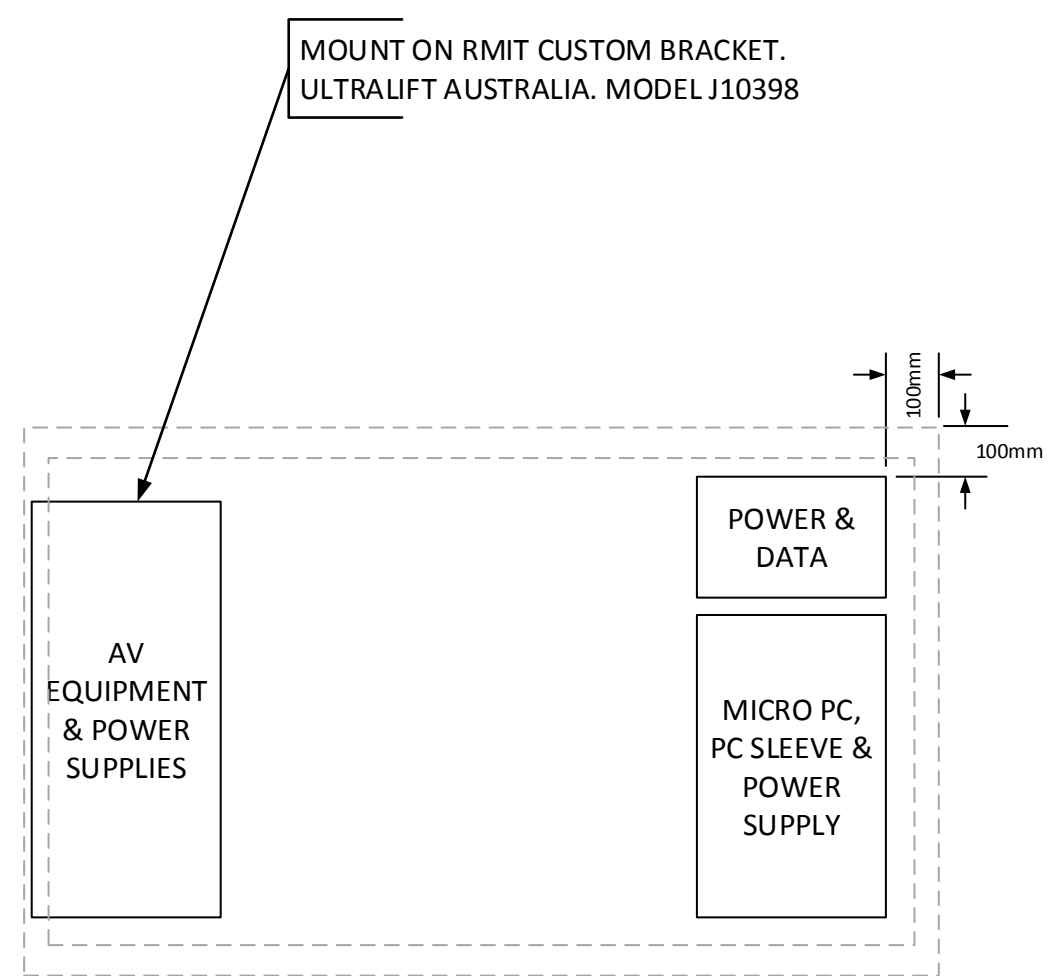

1 MEETING/CONFERENCE ROOM – EQUIPMENT LAYOUT BEHIND LCD SCREEN
- NTS

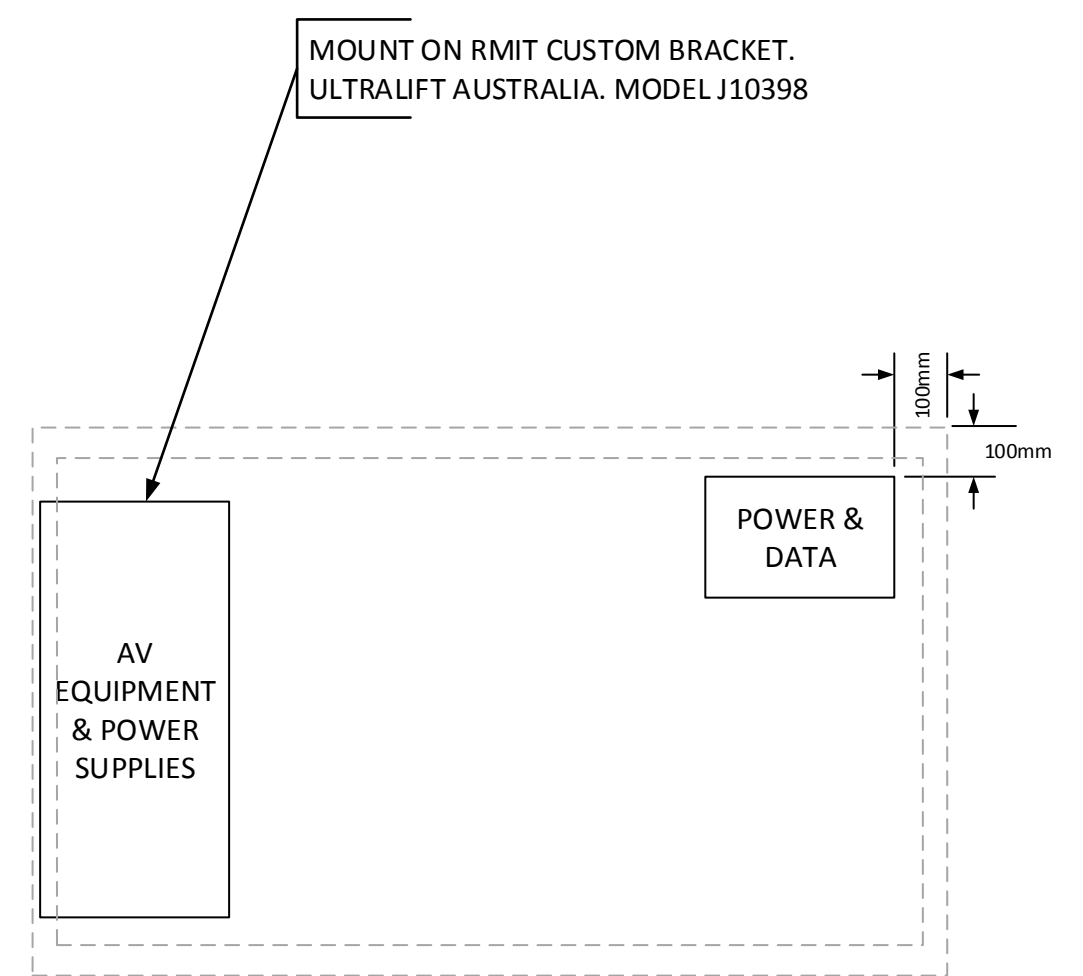

2 FLAT FLOOR TEACHING – EQUIPMENT LAYOUT BEHIND LCD SCREEN
- NTS

NOTES
1. If two (2) Ultralift Australia J10398 brackets are required behind the screen, this is acceptable assuming there is adequate space behind the screen for it to be hidden

ANY DEVIATION FROM THE ABOVE AV STANDARD MUST BE APPROVED BY RMIT AV

				DRAWING DESCRIPTION: AV DETAIL DRAWING INDICATIVE EQUIPMENT LAYOUT (DISPLAY DEVICE)							
PROJECT NAME				RMIT AV STANDARDS							
DESIGNED	DRAWN	CHECKED	PROJECT REF NO	DOCUMENT REF NO	REV	PAPER SIZE	SCALE	SHEET			
NK	NK	AA	AV STANDARD	AV-D-04	A	A1	NTS	5 OF 6			
REV	PURPOSE OF ISSUE			DATE	ISSUED BY						
A	ITS AVS 3.00 ISSUE			04 MAY 18	NK						

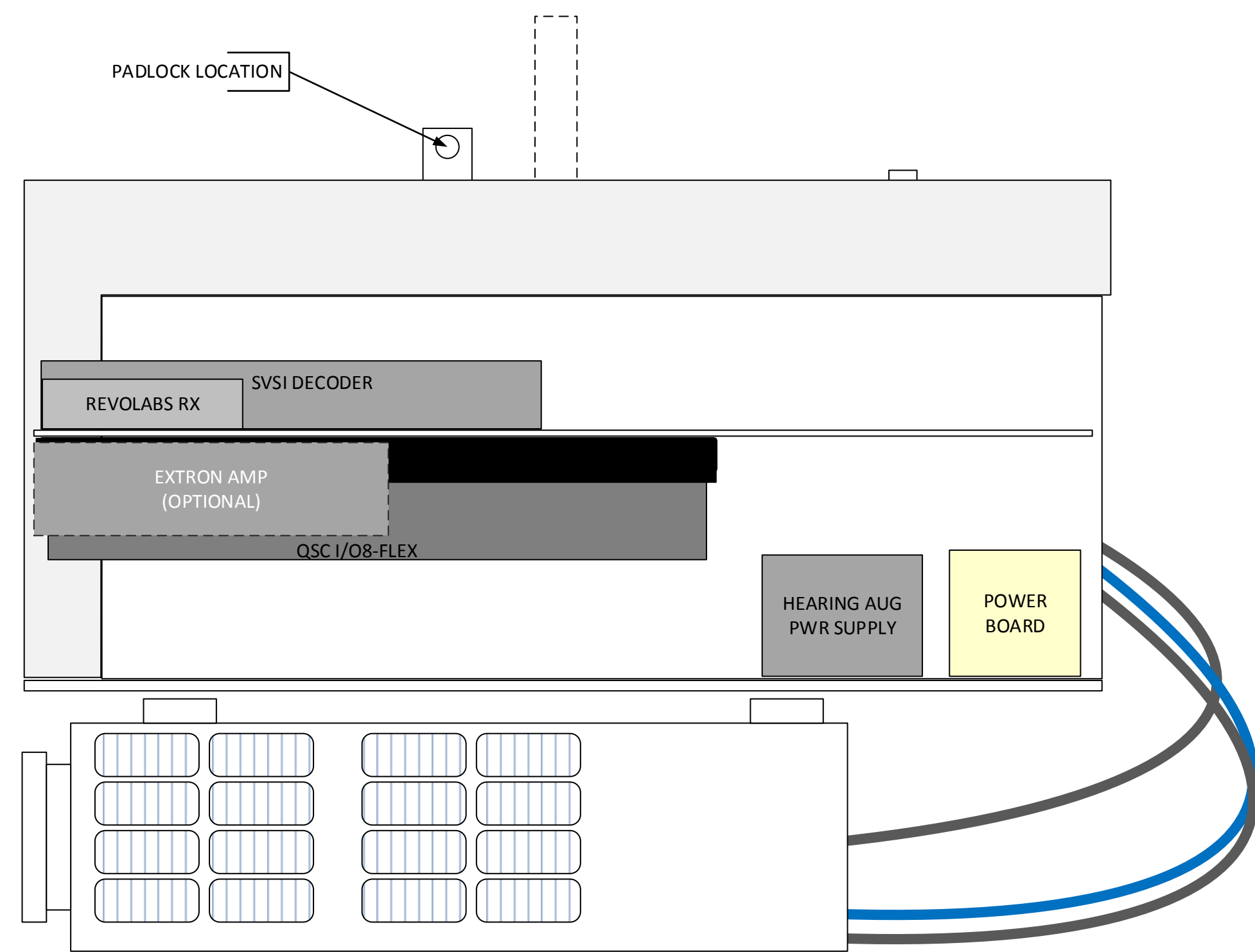

1 SIDE VIEW
- NTS

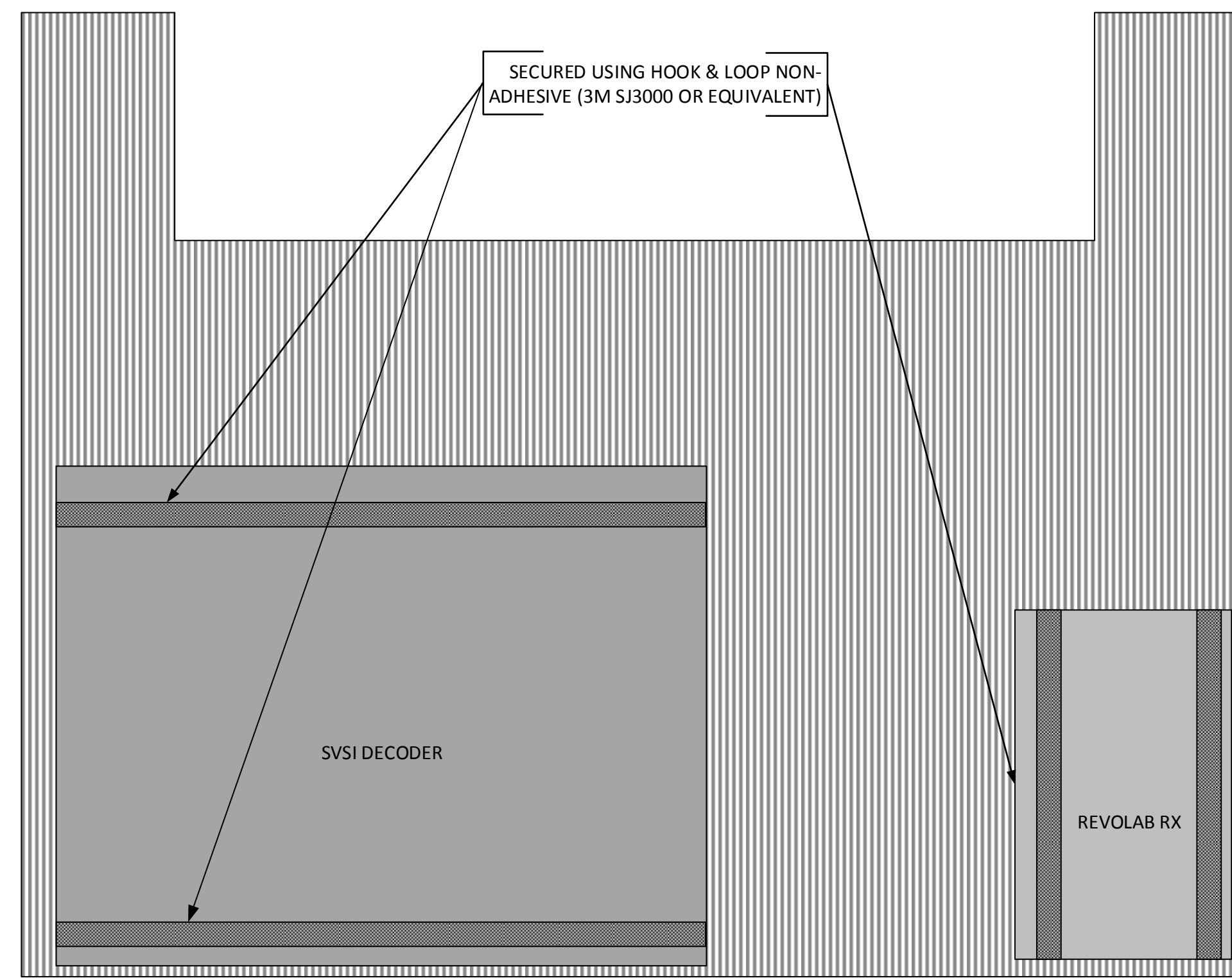

2 PLAN VIEW OF SLOTTED SHELF
- NTS

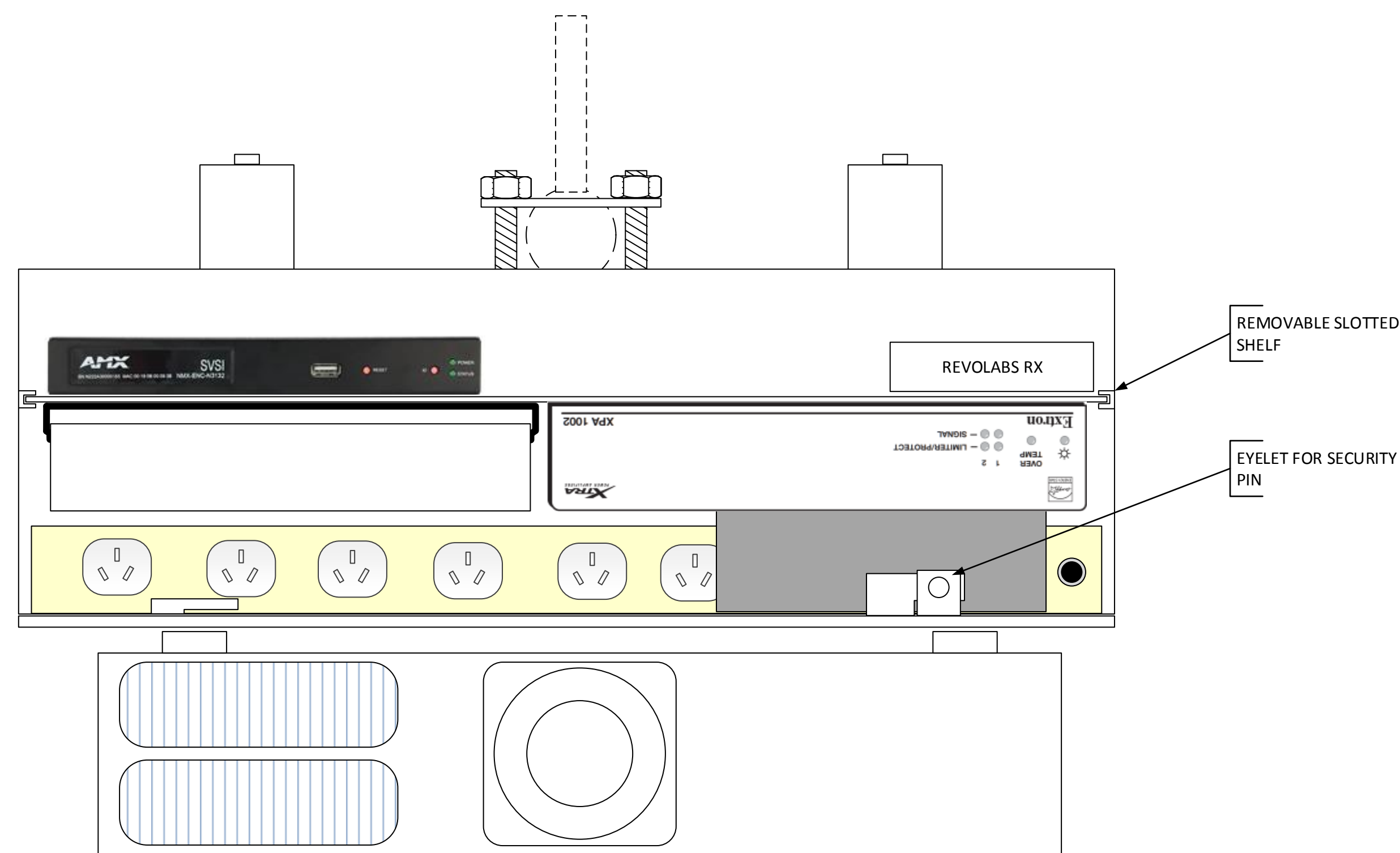

3 FRONT VIEW
- NTS

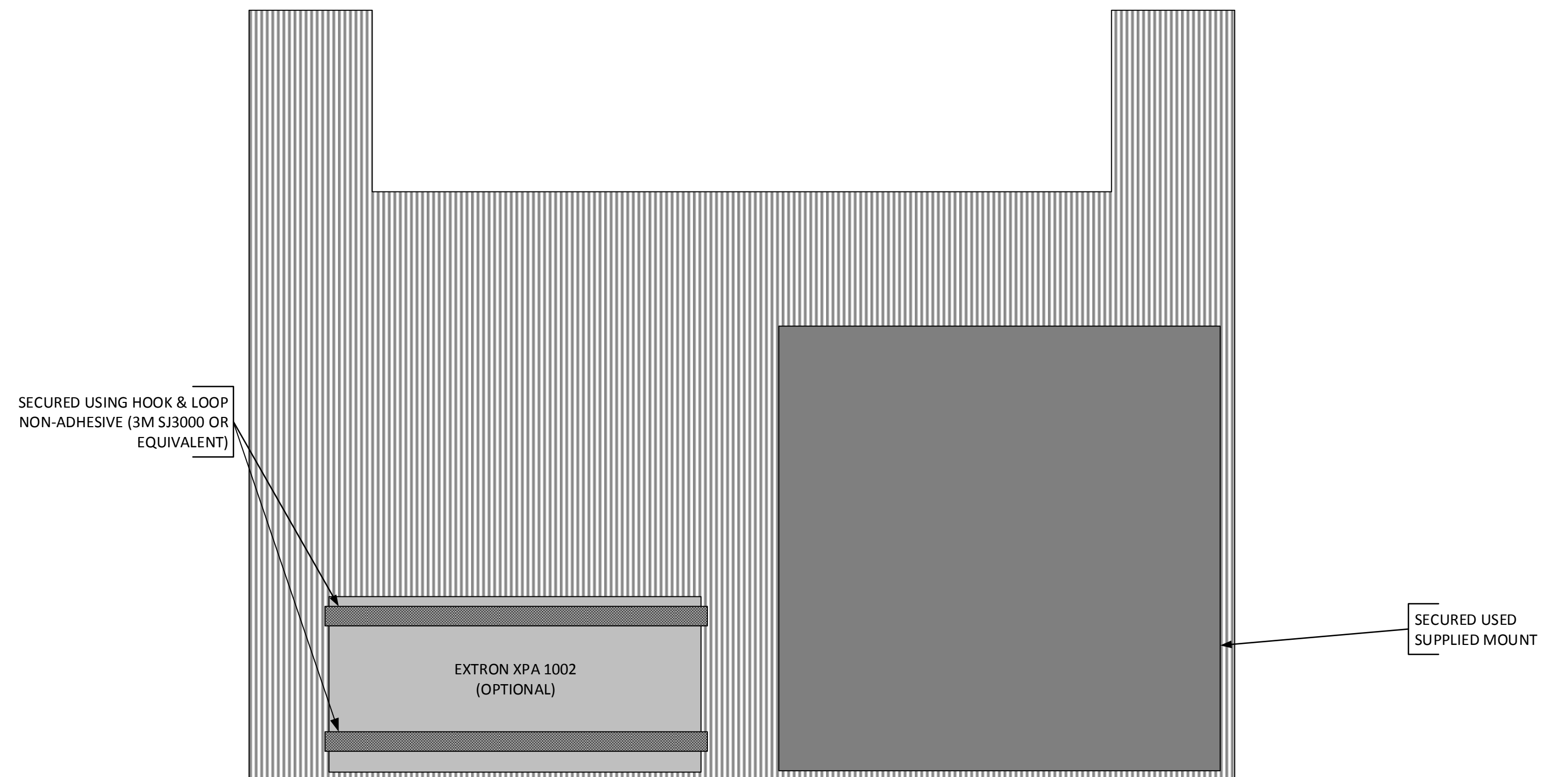

4 UNDERSIDE OF SLOTTED SHELF
- NTS

NOTES:
-

ANY DEVIATION FROM THE ABOVE AV STANDARD MUST BE APPROVED BY RMIT AV

A	ITS AVS 3.00 ISSUE	04 MAY 18	NK	PAPER SIZE	SCALE	SHEET	DESIGNED	DRAWN	CHECKED	PROJECT REF NO	DOCUMENT REF NO	REV
REV	PURPOSE OF ISSUE	DATE	ISSUED BY	A1	NTS	6 OF 6	NK	NK	AA	AV STANDARD	AV-D-05	A

RMIT UNIVERSITY

DRAWING DESCRIPTION:
AV DETAIL DRAWING
EQUIPMENT LAYOUT (PROJECTOR CAGE IN FLAT-FLOOR TEACHING)

PROJECT NAME:
RMIT AV STANDARDS